

EWM-S-AD

ANALOGUE POSITIONING CARD FOR STROKE CONTROL IN CLOSED LOOP SYSTEMS WITH DIGITAL FEEDBACK SERIES 20



**RAIL MOUNTING TYPE:
DIN EN 50022**

OPERATING PRINCIPLE

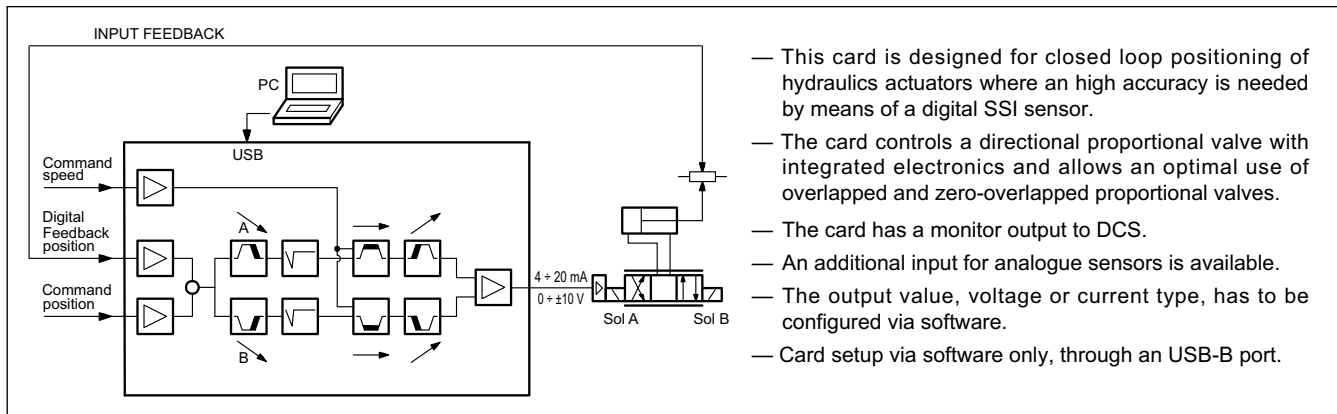

TECHNICAL CHARACTERISTICS

| | | |
|--|---------|--|
| Power supply | V DC | 24 ÷ 30 ripple included |
| Fuse, external | A | 1A medium time lag |
| Current consumption | mA | 350 (technical data of the sensor have to be considered) |
| Command position | mA V | 4 ÷ 20 (RI = 240 Ω) 0 ÷ 10 (RI = 25 kΩ) |
| Max position accuracy | µm | 1 |
| Command speed | V | 0 ÷ 10 (RI = 90 kΩ) 4 ÷ 20 (RI = 240 Ω) |
| Feedback value | | Digital sensor with SSI interface RS-422, 150kBaud |
| Output value | V mA | differential, ±10 (max load 10 mA 2 kΩ) 4 ÷ 20 (max load 390 Ω) |
| Interface | | USB - B 2.0 |
| Electromagnetic compatibility (EMC) 2014/30/EU | | Immunity EN 61000-6-2: 8/2005 Emissions EN 61000-6-4: 6/2007; A1:2011 |
| Housing material | | thermoplastic polyamide PA6.6 - combustibility class V0 (UL94) |
| Housing dimensions | mm | 120(d) x 99(h) x 46(w) |
| Connections | | USB-B (2.0) - 7x4 poles screw terminals - PE direct via DIN rail |
| Operating temperature range | °C | -20 / +60 |
| Protection degree | | IP 20 |

Архангельск (8182)63-90-72
Астана (7172)727-132
Астрахань (8512)99-46-04
Барнаул (3852)73-04-60
Белгород (4722)40-23-64
Брянск (4832)59-03-52
Владивосток (423)249-28-31
Волгоград (844)278-03-48
Вологда (8172)26-41-59
Воронеж (473)204-51-73
Екатеринбург (343)384-55-89
Иваново (4932)77-34-06

Ижевск (3412)26-03-58
Иркутск (395)279-98-46
Казань (843)206-01-48
Калининград (4012)72-03-81
Калуга (4842)92-23-67
Кемерово (3842)65-04-62
Киров (8332)68-02-04
Краснодар (861)203-40-90
Красноярск (391)204-63-61
Курск (4712)77-13-04
Липецк (4742)52-20-81

Магнитогорск (3519)55-03-13
Москва (495)268-04-70
Мурманск (8152)59-64-93
Набережные Челны (8552)20-53-41
Нижний Новгород (831)429-08-12
Новокузнецк (3843)20-46-81
Новосибирск (383)227-86-73
Омск (3812)21-46-40
Орел (4862)44-53-42
Оренбург (3532)37-68-04
Пенза (8412)22-31-16

Пермь (342)205-81-47
Ростов-на-Дону (863)308-18-15
Рязань (4912)46-61-64
Самара (846)206-03-16
Санкт-Петербург (812)309-46-40
Саратов (845)249-38-78
Севастополь (8692)22-31-93
Симферополь (3652)67-13-56
Смоленск (4812)29-41-54
Сочи (862)225-72-31
Ставрополь (8652)20-65-13

Сургут (3462)77-98-35
Тверь (4822)63-31-35
Томск (3822)98-41-53
Тула (4872)74-02-29
Тюмень (3452)66-21-18
Ульяновск (8422)24-23-59
Уфа (347)229-48-12
Хабаровск (4212)92-98-04
Челябинск (351)202-03-61
Череповец (8202)49-02-64
Ярославль (4852)69-52-93

Киргизия (996)312-96-26-47

Россия (495)268-04-70

Казахстан (772)734-952-31

1 - IDENTIFICATION CODE

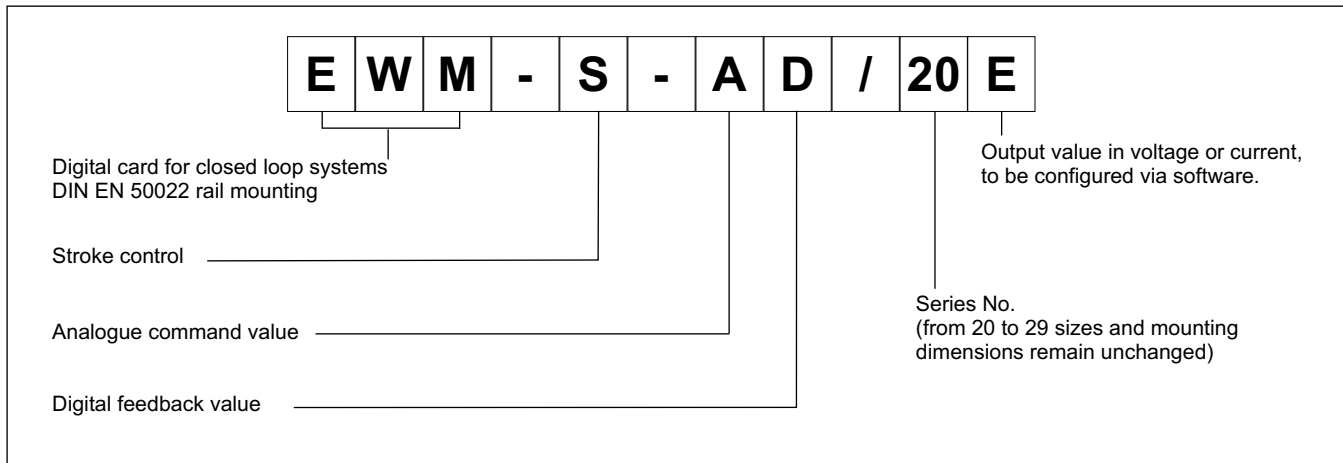

2 - FEATURES OVERVIEW

Controller Functions

- Stroke positioning control in closed loop system
- Fine positioning - 1µm resolution
- 2 different operating mode:
 - SDD – Stroke Depending Deceleration - time-optimal positioning structure with very high stability
 - NC – Numerically Controlled - To follow the position profile
- Gain adjustment made via software
- PT1 filter to stabilize the control behaviour
- Emergency function (EOUT)
- Analog signal command
- Digital feedback input
- Velocity limited internally or by analog input
- Safe and error-free data transmission
- As an alternative, the card can be set via software for operate with analogue sensors.
- Simple and intuitive scaling for analogue sensors

Adaptation of the valve characteristic curve

- CTRL function to adapt the braking characteristics to positive and zero overlapped proportional valves
- Advanced deadband compensation: non-linearity compensation by a double-gain characteristics
- Drift compensation

Monitoring functions

- In-position error
- Cable break for command signal and fault of feedback sensor
- 2 Digital output to read the status
- Monitor output to DCS

Other characteristics

- Output value in voltage or current, to be configured via software.
- Card configuration is made via software, through on-board USB

3 - FUNCTIONAL SPECIFICATIONS

3.1 - Power supply

This card is designed for 24 to 30 VDC (typical 24 V) of a power supply. This power supply must correspond to the actual EMC standards. All inductivities at the same power supply (relays, valves) must be provided with an over voltage protection (varistors, freewheeling diodes).

It is recommended to use a regulated power supply (linear or switching mode) for the card supply and for the sensors.

3.2 - Electrical protections

All inputs and outputs are protected with suppressor diodes and RC-filters against transient overshoots.

3.3 - Digital Input

The card accepts digital input. The digital input must have a voltage from 12 to 24 V; Low level: <2V, high level >10V. Input resistance 25 kΩ. See the block diagram at paragraph 4 for the electric connections.

3.4 - External command position

The card accepts an analogue input signal. The command value can be 0 ÷ 10 V (RI = 25 kΩ) or 4 ÷ 20 mA (RI = 240 Ω).

3.5 - External command speed

The card accepts an analogue input signal. The command speed can be 0 ÷ 10 V (RI = 90 kΩ) or 4 ÷ 20 mA (RI = 240 Ω).

3.6 - Feedback value

The card accepts a digital feedback input from a sensor with any SSI interface with RS422 specifications. Bit, code and resolution are settable via software.

The max sensor resolution is 0,001 mm.

Eventually an analog input could be used as feedback. The card accepts a 0 ÷ 10 V (Ri 25 kΩ) or 4 ÷ 20 mA (Ri = 240 Ω)

3.7 - Analog output values

Output values can be in voltage or current, to be configured via software (parameter SIGNAL:U). The same parameter defines the polarity also.

Voltage: ± 10 V Differential output

(0 ÷ 10 V at PIN 15 and 0 ÷ 10 V at PIN 16).

Current: 4 ÷ 20 mA (PIN 15 to PIN 12).

An analogue position value 0 ÷ 10 V (max load 10mA) is available at PIN 17 as sensor monitor reference.

3.9 - Digital Output

Two digital output are available, INPOS and READY, that are displayed by LED on the front panel.

Low level < 2 V High Level > 12 V (50 mA).

4 - WIRING DIAGRAM

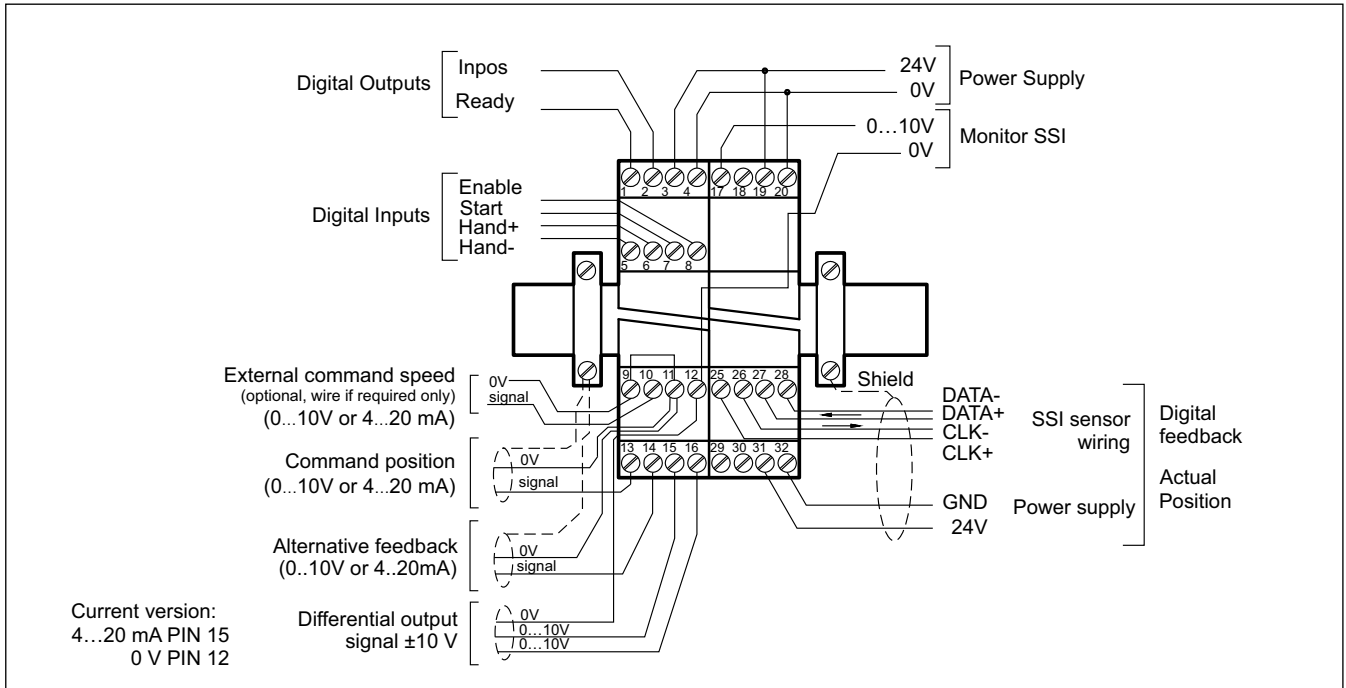

DIGITAL INPUT AND OUTPUT

- PIN 1** READY output.
General operability, ENABLE is active and there is no sensor error. This output corresponds with the green led.
- PIN 2** STATUS output.
Monitoring of the control error (INPOS). Depending on the INPOS command, the status output will be deactivated, if the position difference is greater than the adjusted window.
The output is only active if START = ON.
- PIN 5** HAND- input
Hand mode (START = OFF), driving with the programmed velocity. After deactivation the actual value is taken over as command position.
- PIN 6** HAND+ input:
Hand mode (START = OFF), driving with the programmed velocity. After deactivation the actual value is taken over as command position.
- PIN 7** START input:
The positioning controller is active; the external analogue command position is taken over as command value. If the input is switched off during movement, the command position is set to the actual position plus a defined emergency deceleration stroke.
- PIN 8** Enable input:
This digital input signal initializes the application. The analogue output is active and the READY signal indicates that all components are working correctly. Target position is set to actual position and the drive is closed loop controlled.

ANALOGUE INPUT

- PIN 9/10** External command speed (V)
range 0 + 100 %
corresponds to 0 + 10V or 4 + 20 mA
- PIN 13/11** Command position (WA)
range 0 + 100%
corresponds to 0 + 10V or 4 + 20 mA
- PIN 11/14** Alternative: analogue feedback value (X)
range 0 + 100% corresponds to 0 + 10V or 4 + 20 mA

ANALOGUE OUTPUT voltage

- PIN 16/15** Differential output (U)
 $\pm 100\%$ corresponds to $\pm 10V$ differential voltage

current

- PIN 12/15** $\pm 100\%$ corresponds to 4 + 20 mA
- PIN 12/17** Monitor of the SSI sensor position
0 + 10V

5 - INSTALLATION

For power supply and solenoid connections are recommended cable sections of 0.75 mm² up to 20 m length, and of 1.00 mm² up to 40m length.

For other connections use cables with a shielded jacket, connected to GND only on the card side.

NOTE : To observe EMC requirements it is important that the control unit electrical connection is in strict compliance with the wiring diagram.

As a general rule, the valve and the electronic unit connection wires must be kept as far as possible from interference sources (e.g. power wires, electric motors, inverters and electrical switches).

Complete protection of the connection wires can be requested in environments with critical electromagnetic interferences.

5.1 Start-up

The module must be mounted and wired with attentions to EMC requirements. A star orientated ground connection should be used when other power consumers are sharing the same power supply. Following points have to be taken in account for wiring:

- Signal cable and power cable have to be wired separately.
- Analogue signal cables must be shielded.
- Other cables should be shielded in case of strong electrical disturbance (power relays, frequency controlled power driver) or at cable lengths > 3m.

With high frequency EMI inexpensive ferrite elements can be used.

Take in account a separation between the power part (and power cables) and signal part when arrange the areas inside the electrical cabinet. Experience shows us that the area next to the PLC (24 V area) is suitable.

Low impedance between PE "protected earth" and DIN-Rail should be used. Transient interference voltages at the terminals are discharged via DIN-Rail to the local PE. The screens have to be connected directly next to the module via PE terminals.

The power supply should be carried out voltage regulated (i. e. PWM controlled). The low impedance of controlled power supplies facilitates improved interference damping, therefore the signal resolution will be increased.

Switched inductance (relays and solenoids) operating from the same power supply has to be damped by surge protection elements directly by the inductance.

6 - DEVICE SETUP

Card set-up is possible via software only.

The system can be controlled in open loop, moving up and down the servo-cylinder with commands HAND+ and HAND- to facilitate the adjustment of the card and its calibration. With these functions the setting-up and the adjustments become easy.

6.1 - Software EWMPC/20

The software EWMPC/20 can be easily downloaded from the Diplomatic MSa website in the section SOFTWARE DOWNLOAD.

To connect the card to a PC or notebook is necessary a standard USB 2.0 cable A – B (standard USB printer cable).

Once connected, the software automatically recognises the card model and shows a table with all the available commands, their parameters, the default setting, the measuring unit and a brief explanation for correct set-up.

Some functions like baud rate setting, remote control mode, saving of process data for later evaluation are used to speed up the installation procedure.

The software is compliant with Microsoft OS Windows 7 and 8.

WARNING! For card series 20, the default baud rate to select in the software has changed from 9600 baud to 57600 baud. This is adaptable in OPTION / SETTINGS / INTERFACE.



6.2 - Parameters table

The parameters table is available in English or German. The language is set in the parameters.

The parameter setting can be done at standard level, easier, or expert, where a greater number of parameters is displayed and can be customized.

For a complete list of the parameters and their settings please refer to the Technical Manual 89420-115 ETM.

7 - MAIN FEATURES

7.1 - Sequence of the positioning

The positioning process will be controlled by switching inputs. After enabling (ENABLE input), the command position is set to the actual position of the sensor and the axis is in closed loop position control mode.

The READY output indicates a general ready to operate.

The axis can be driven in manual mode with the digital inputs HAND+ or HAND- , at programmed velocity.

When the manual mode are switched off, the command position is set to the actual position and the system is in closed loop position control mode.

With START input, the analogue command input is active and new command positions will be taken over. The axis is immediately driving to this new position and indicates on the Inpos Output when the axis reaches the position. This output is active as long as the axis is within the InPos window or the START input is active.

Two operating modes can be selected:

SDD - stroke depending deceleration - means the control gain will be adjusted. This is a time-optimal positioning structure with very high stability.

NC mode - the position value is generated from the following error. The actuator position is measured by a transducer and compared with a specified target position. The target position is adjusted with an external potentiometer or preset by an analog input from an external controller (PLC). It's possible to define the axis speed also by an external command speed.

The positioning accuracy will almost be limited by the resolution of the transducer, and by the right size of the hydraulic valve. Therefore, the correct valve selection is the most important point. Additionally, two clashing requirements (short positioning time and high accuracy) have to be considered in the system design.

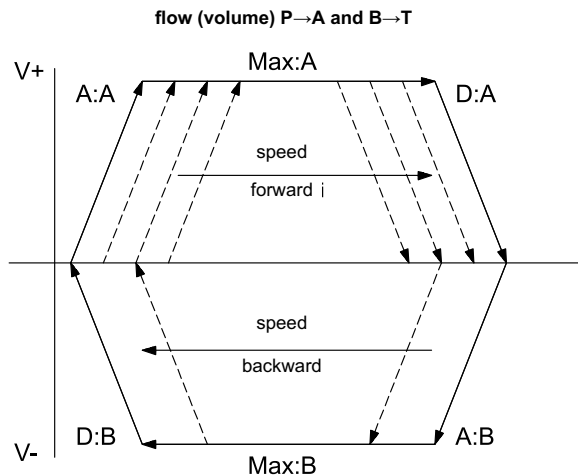

7.2 - Gain

The gain is settable and it's related with the braking distance (parameters available via software). Lower is the braking distance, higher is the gain.

7.3 - Emergency Output (EOUT)

This function is able to set the output at a specific value when a failure occurs (e.g. sensor error or ENABLE disabled). It can be used to move the axis to one of the two end positions with a programmed velocity. The function can be deactivate.

7.4 - Adaptation of the braking characteristic to the valve type (CTRL).

The deceleration characteristic is set with this parameter. In case of positively overlapped proportional valves the SQRT function should be used. The non-linear flow function of these valves is linearized by the SQRT function.

In case of zero lapped valves (control valves and servo valves) the LIN or SQRT1 function should be used regardless of the application. The progressive characteristic of the SQRT1 function has better positioning accuracy but can also lead to longer positioning times in individual cases.

LIN: Linear deceleration characteristic (gain is increased by a factor of 1).

SQRT1: Root function for braking curve calculation. The gain is increased by a factor of 3 (in the target position). This is the default setting.

SQRT2: Root function for braking curve calculation. The gain is increased by a factor of 5 (in the target position). This setting should only be used with a significantly progressive flow through the valve.

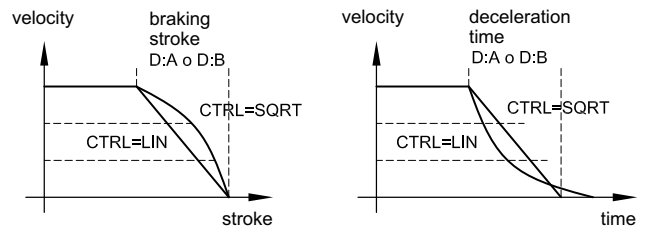

7.5 - Adaptation of the output signal to the valve characteristic (TRIGGER).

With TRIGGER command, the output signal is adapted to the valve characteristics.

The positioning controllers have a double-gain characteristic curve instead of a typical overlapped jump. The advantage is a better and more stable positioning behaviour. With this compensation, non-linear volume flow characteristic curves can be adjusted too.

If there exist also possibilities for adjustments at the valve or at the valve electronics, it has to be guaranteed, that the adjustment has to be carried out at the power amplifier or at the positioning module.

If the deadband compensation value (MIN) is set too high, it influences the minimal velocity which cannot be adjusted any longer.

In extreme cases this causes to an oscillating around the closed loop controlled position.

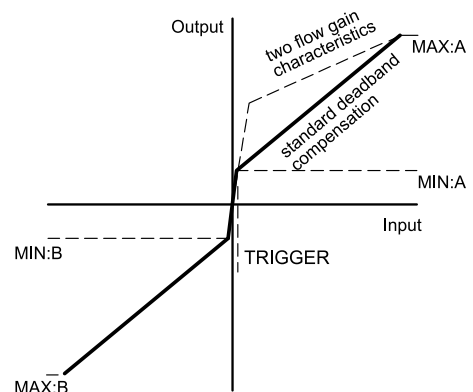

8 - STANDARD CARD BLOCK DIAGRAM

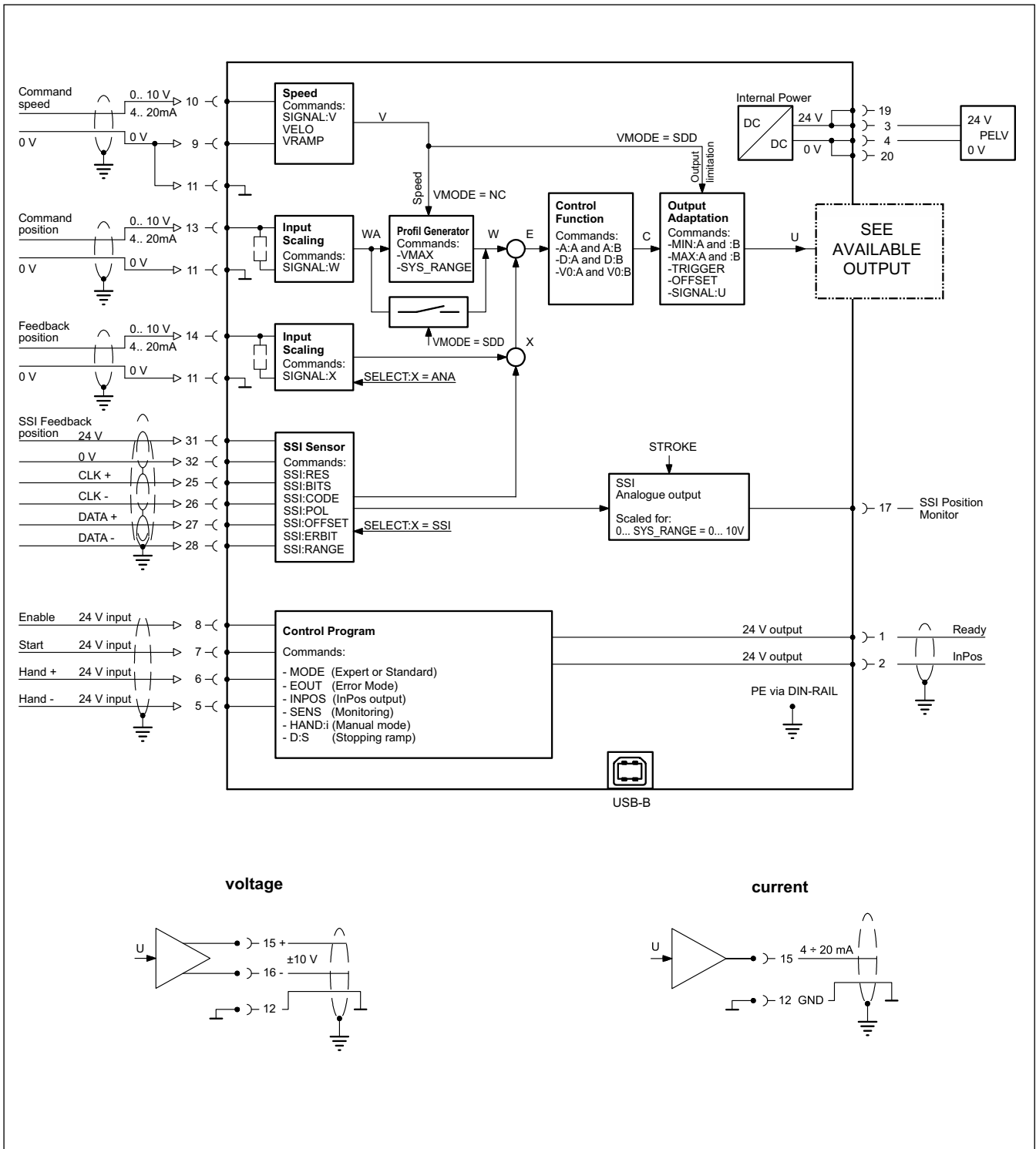

9 - OVERALL AND MOUNTING DIMENSIONS

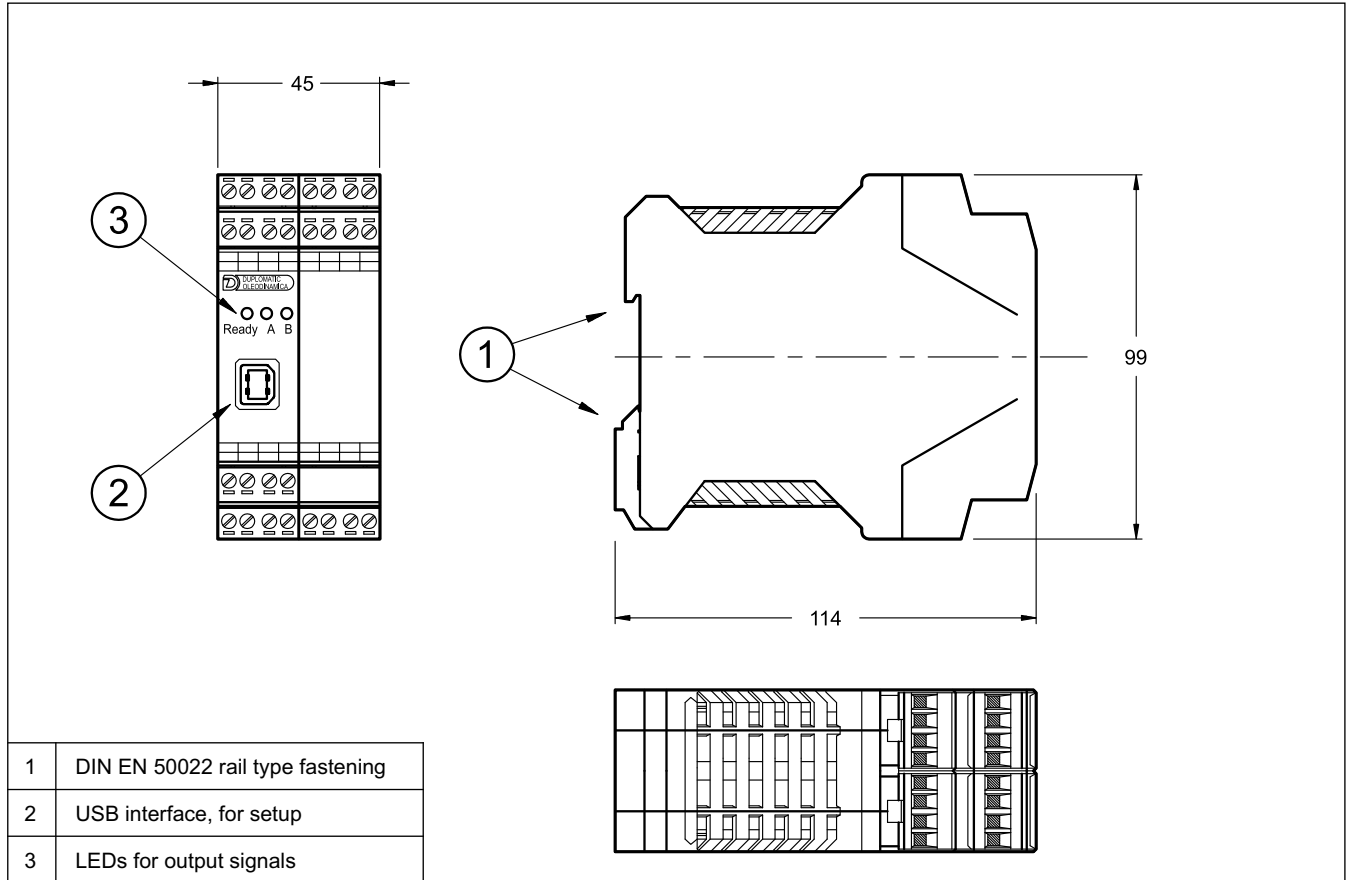

Архангельск (8182)63-90-72
 Астана (7172)727-132
 Астрахань (8512)99-46-04
 Барнаул (3852)73-04-60
 Белгород (4722)40-23-64
 Брянск (4832)59-03-52
 Владивосток (423)249-28-31
 Волгоград (844)278-03-48
 Вологда (8172)26-41-59
 Воронеж (473)204-51-73
 Екатеринбург (343)384-55-89
 Иваново (4932)77-34-06

Ижевск (3412)26-03-58
 Иркутск (395)279-98-46
 Казань (843)206-01-48
 Калининград (4012)72-03-81
 Калуга (4842)92-23-67
 Кемерово (3842)65-04-62
 Киров (8332)68-02-04
 Краснодар (861)203-40-90
 Красноярск (391)204-63-61
 Курск (4712)77-13-04
 Липецк (4742)52-20-81

Магнитогорск (3519)55-03-13
 Москва (495)268-04-70
 Мурманск (8152)59-64-93
 Набережные Челны (8552)20-53-41
 Нижний Новгород (831)429-08-12
 Новокузнецк (3843)20-46-81
 Новосибирск (383)227-86-73
 Омск (3812)21-46-40
 Орел (4862)44-53-42
 Оренбург (3532)37-68-04
 Пенза (8412)22-31-16

Пермь (342)205-81-47
 Ростов-на-Дону (863)308-18-15
 Рязань (4912)46-61-64
 Самара (846)206-03-16
 Санкт-Петербург (812)309-46-40
 Саратов (845)249-38-78
 Севастополь (8692)22-31-93
 Симферополь (3652)67-13-56
 Смоленск (4812)29-41-54
 Сочи (862)225-72-31
 Ставрополь (8652)20-65-13

Сургут (3462)77-98-35
 Тверь (4822)63-31-35
 Томск (3822)98-41-53
 Тула (4872)74-02-29
 Тюмень (3452)66-21-18
 Ульяновск (8422)24-23-59
 Уфа (347)229-48-12
 Хабаровск (4212)92-98-04
 Челябинск (351)202-03-61
 Череповец (8202)49-02-64
 Ярославль (4852)69-52-93

Киргизия (996)312-96-26-47

Россия (495)268-04-70

Казахстан (772)734-952-31

<https://diplomatic.nt-rt.ru/> || dcw@nt-rt.ru