

DL5

SOLENOID OPERATED DIRECTIONAL CONTROL VALVE COMPACT VERSION SERIES 10

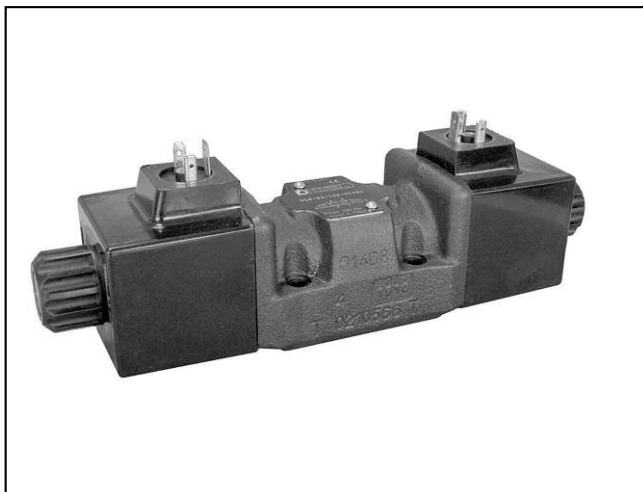

SUBPLATE MOUNTING ISO 4401-05

p max 320 bar
Q max 125 l/min

MOUNTING INTERFACE

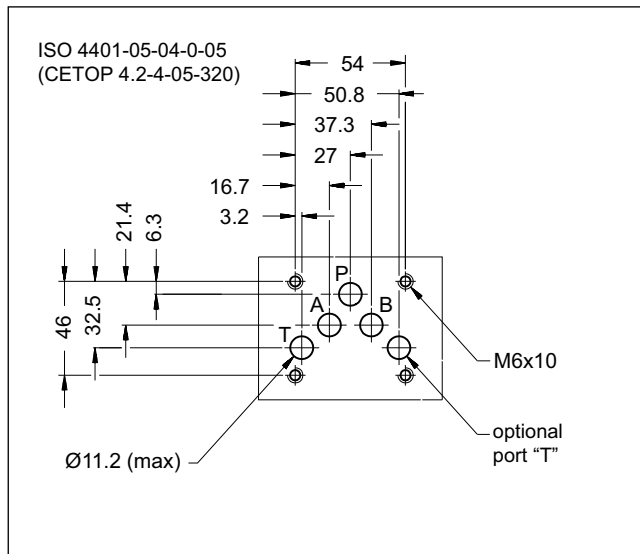

OPERATING PRINCIPLE

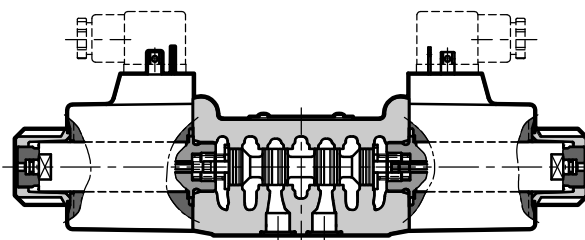

- Direct acting, subplate mounting directional control valve, with mounting surface according to ISO 4401 standards.
- The valve is suitable for special applications, guaranteed by the reduced solenoid dimensions.
- The valve body is made with high strength iron castings provided with wide internal passages in order to minimize the flow pressure drop. Wet armature solenoids with interchangeable coils are used (for further information on solenoids see paragraph 7).
- The valve is supplied with 3 or 4 way designs and with several interchangeable spools with different porting arrangements.
- The valve is available with DC or AC current solenoids.

PERFORMANCES

(with mineral oil of viscosity of 36 cSt at 50°C)

Maximum operating pressure: - ports P - A - B - port T	bar	CC	CA
		320	160
Maximum flow rate	l/min	125	100
Pressure drop $\Delta p-Q$	see paragraph 4		
Operating limits	see paragraph 5		
Electrical features	see paragraph 7		
Electrical connections	EN 175301-803 (ex DIN 43650)		
Ambient temperature range	°C	-20 / +50	
Fluid temperature range	°C	-20 / +80	
Fluid viscosity range	cSt	10 ÷ 400	
Fluid contamination degree	according to ISO 4406:1999 class 20/18/15		
Recommended viscosity	cSt	25	
Masse: single solenoid valve double solenoid valve	kg	2,8 3,7	

Архангельск (8182)63-90-72
Астана (7172)727-132
Астрахань (8512)99-46-04
Барнаул (3852)73-04-60
Белгород (4722)40-23-64
Брянск (4832)59-03-52
Владивосток (423)249-28-31
Волгоград (844)278-03-48
Вологда (8172)26-41-59
Воронеж (473)204-51-73
Екатеринбург (343)384-55-89
Иваново (4932)77-34-06

Ижевск (3412)26-03-58
Иркутск (395)279-98-46
Казань (843)206-01-48
Калининград (4012)72-03-81
Калуга (4842)92-23-67
Кемерово (3842)65-04-62
Киров (8332)68-02-04
Краснодар (861)203-40-90
Красноярск (391)204-63-61
Курск (4712)77-13-04
Липецк (4742)52-20-81

Магнитогорск (3519)55-03-13
Москва (495)268-04-70
Мурманск (8152)59-64-93
Набережные Челны (8552)20-53-41
Нижний Новгород (831)429-08-12
Новокузнецк (3843)20-46-81
Новосибирск (383)227-86-73
Омск (3812)21-46-40
Орел (4862)44-53-42
Оренбург (3532)37-68-04
Пенза (8412)22-31-16

Пермь (342)205-81-47
Ростов-на-Дону (863)308-18-15
Рязань (4912)46-61-64
Самара (846)206-03-16
Санкт-Петербург (812)309-46-40
Саратов (845)249-38-78
Севастополь (8692)22-31-93
Симферополь (3652)67-13-56
Смоленск (4812)29-41-54
Сочи (862)225-72-31
Ставрополь (8652)20-65-13

Сургут (3462)77-98-35
Тверь (4822)63-31-35
Томск (3822)98-41-53
Тула (4872)74-02-29
Тюмень (3452)66-21-18
Ульяновск (8422)24-23-59
Уфа (347)229-48-12
Хабаровск (4212)92-98-04
Челябинск (351)202-03-61
Череповец (8202)49-02-64
Ярославль (4852)69-52-93

Киргизия (996)312-96-26-47

Россия (495)268-04-70

Казахстан (772)734-952-31

1 - IDENTIFICATION CODE

	D	L	5	-		/	10		-		K1	/		
--	----------	----------	----------	---	--	---	-----------	--	---	--	-----------	---	--	--

Solenoid operated directional control valve

Model in compact execution

ISO 4401-05 size

Spool type (see paragraph 3):

S* **TA***
SA* **TB***
SB* **RK**

Series no.: (the overall and mounting dimensions remain unchanged from 10 to 19)

Seals:

N = NBR seals for mineral oil (**standard**)
V = FPM seals for special fluids

Option:
/ **W7** = Zinc-nickel surface treatment.
Omit if not required (see **NOTE 2**)

Manual override - see par. 12
Omit for override integrated in the tube (**standard**)
CM = boot protected.
For DC version only.

Coil electrical connection:
plug for connector type
EN 175301-803 (ex DIN 43650)
(**standard**)

DC power supply

D12 = 12 V
D24 = 24 V
D00 = valve without coils (see **NOTE 1**)

AC power supply

A24 = 24 V - 50 Hz
A48 = 48 V - 50 Hz
A110 = 110 V - 50 Hz
A230 = 230 V - 50 Hz
A00 = valve without coils (see **NOTE 1**)

NOTE 1: Coils locking ring and related OR are supplied together with valves.

NOTE 2: The standard valve is supplied with surface treatment of phosphating black.

The zinc-nickel finishing makes the valve suitable to ensure a salt spray resistance up to 240 hours (test operated according to EN ISO 9227 standards and test evaluation operated according to UNI EN ISO 10289 standards).

2 - HYDRAULIC FLUIDS

Use mineral oil-based hydraulic fluids HL or HM type, according to ISO 6743-4. For these fluids, use NBR seals (code N). For fluids HFDR type (phosphate esters) use FPM seals (code V). For the use of other fluid types such as HFA, HFB, HFC, please consult our technical department. Using fluids at temperatures higher than 80 °C causes a faster degradation of the fluid and of the seals characteristics. The fluid must be preserved in its physical and chemical characteristics.

3 - SPOOL TYPE

Type S*:
2 solenoids - 3 positions
with spring centreing

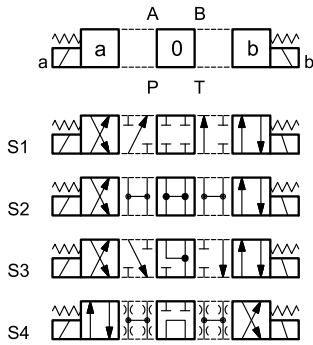

Type SA*:
1 solenoid side A
2 positions (central + external)
with spring centreing

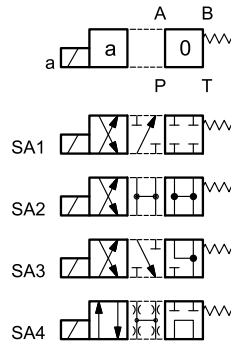

Type SB*:
1 solenoid side B
2 positions (central + external)
with spring centreing

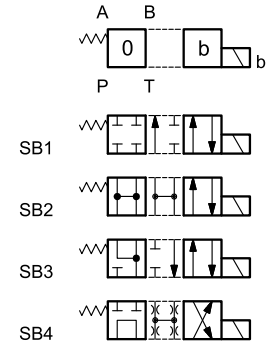

Type RK:
2 solenoids - 2 positions
with mechanical retention

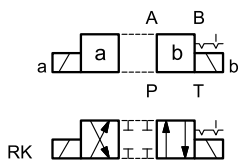

Type TA:
1 solenoid side A
2 external positions
with return spring

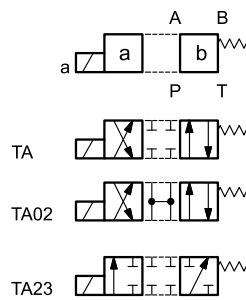

Type TB:
1 solenoid side B
2 external positions
with return spring

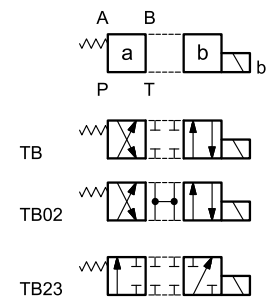

NOTE: Others spools available on request only.

4 - PRESSURE DROPS Δp -Q

(obtained with viscosity of 36 cSt at 50 °C)

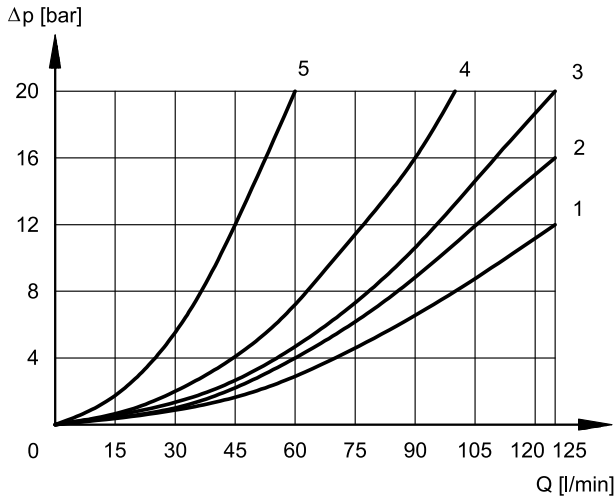

ENERGIZED VALVE

SPOOL	FLOW DIRECTIONS			
	P→A	P→B	A→T	B→T
	CURVES ON GRAPHS			
S1	1	1	2	2
S2	1	1	1	1
S3	1	1	1	1
S4	4	4	4	4
RK	2	2	2	2
TA	2	2	3	3
TA02	2	2	1	1
TA23	3	3	-	-

DE-ENERGIZED VALVE

SPOOL	FLOW DIRECTIONS		
	A→T	B→T	P→T
	CURVES ON GRAPHS		
S2	-	-	1
S3	5	5	-
S4	-	-	1

5 - OPERATING LIMITS

The curves define the flow rate operating fields according to the valve pressure of the different versions. The values indicated in the graphs are relevant to the standard solenoid valve. The operating limits can be considerably reduced if a 4-way valve is used as 3-way valve with port A or B plugged or without flow.

The values have been obtained according to ISO 6403 norm with solenoids at rated temperature and supplied with voltage equal to 90% of the nominal voltage. The value have been obtained with mineral oil, viscosity 36 cSt, temperature 50 °C and filtration according to ISO 4406:1999 class 18/16/13.

5.1 - Standard operating limits

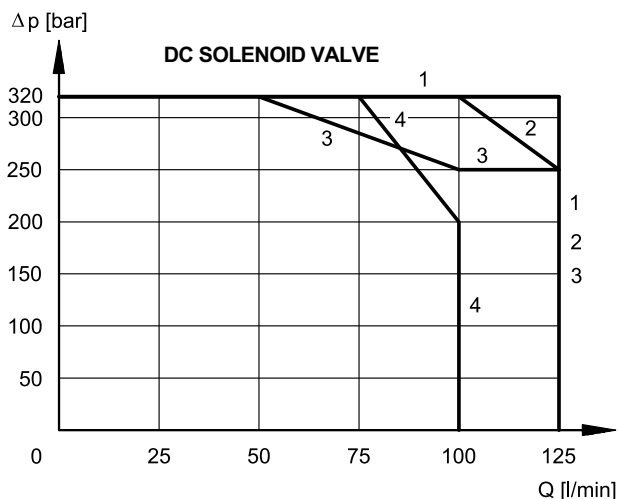

SPOOL	CURVE
S1, S2, RK, TA, TA23	1
S9, TA02	2
S3	3
S4	4

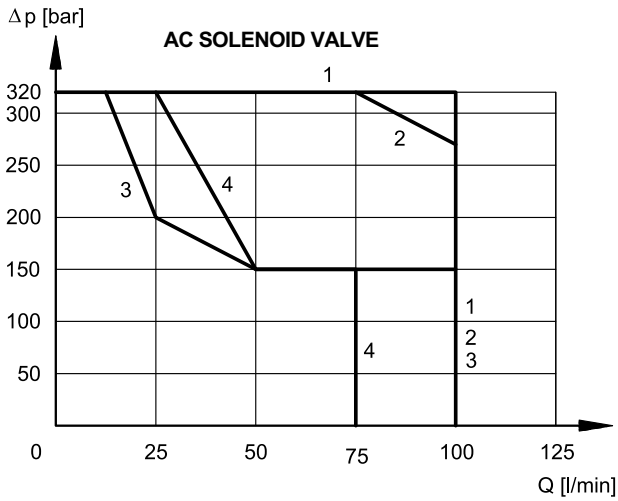

SPOOL	CURVE
S1, RK, TA, TA02, TA23	1
S2	2
S3, S9	3
S4	4

5.2 - 4-way valve in 3-way operation

Operating limits of a 4-way valve in 3-way operation or with port A or B plugged or without flow.

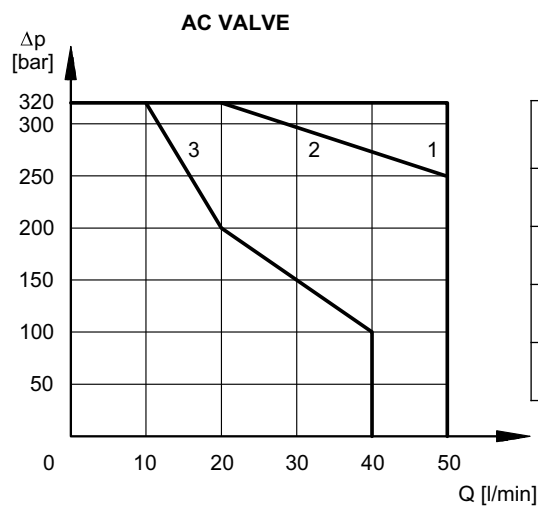
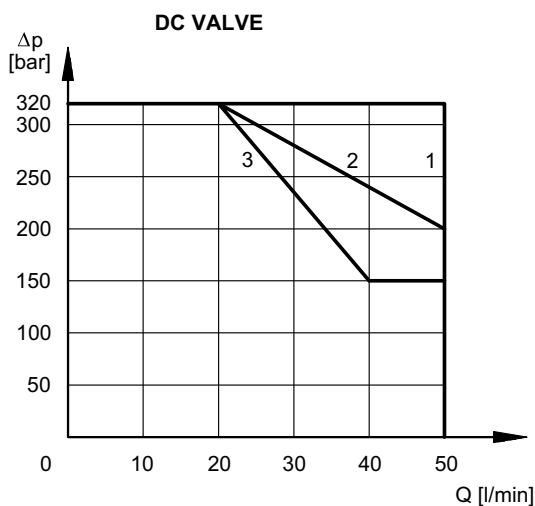

SPOOL	CURVE	
	DC	AC
TA backpr. A TB backpr. B	2	1
TA02 backpr. A TB02 backpr. B	1	1
TA backpr. B TB backpr. A	3	3
TA02 backpr. B TB02 backpr. A	2	2

6 - SWITCHING TIMES

The values indicated are obtained with spool S1, according to ISO 6403 standard, with mineral oil viscosity 36 cSt at 50°C.

SUPPLY	TIMES (±10%) [ms]	
	ENERGIZING	DE-ENERGIZING
DC	40 ÷ 90	20 ÷ 50
AC	15 ÷ 30	20 ÷ 50

7 - ELECTRICAL FEATURES

7.1 - Solenoids

These are essentially made up of two parts: tube and coil. The tube is threaded into the valve body and includes the armature that moves immersed in oil, without wear. The inner part, in contact with the oil in the return line, ensures heat dissipation. The coil is fastened to the tube by a threaded ring, and can be rotated +/- 90°, to suit the available space.

The interchangeability of coils of different voltages is allowed within the same type of supply current, alternating or direct.

SUPPLY VOLTAGE FLUCTUATION	± 10% Vnom
MAX SWITCH ON FREQUENCY	10.000 ins/hr
DUTY CYCLE	100%
ELECTROMAGNETIC COMPATIBILITY (EMC) - NOTE	In compliance with 2014/30/EU
LOW VOLTAGE	In compliance with 2014/35/EU
CLASS OF PROTECTION Atmospheric agents EN 60529 Coil insulation (VDE 0580) Impregnation:	IP65 (*) class H class H

(*) The protection degree is guaranteed only with the connector correctly connected and installed

NOTE: In order to further reduce the emissions, with DC supply, use of type H connectors is recommended. These prevent voltage peaks on opening of the coil supply electrical circuit (see cat. 49 000).

7.2 - DC valve - Current and power consumption

In direct current energizing, current consumption stays at fairly constant values, essentially determined by Ohm's law: $V = R \times I$

The table shows current and power consumption values for DC types.

	Resistance at 20°C [Ω] (±5%)	Current consumption [A] (±10%)	Power consumption [W] (±10%)	Coil code K1
C22L5-D12K1	2,9	4,14	50	1903150
C22L5-D24K1	12,3	1,95	47	1903151

7.3 - AC valve - Current and power consumption

In alternating current energizing, an initial phase (maximum movement) is seen, during which the solenoid consumes elevated value currents (inrush current); the current values diminish during the plunger stroke until it reaches the minimum values (holding current) when the plunger reaches the stroke end.

The table shows the values of absorption at the inrush and at holding.

	Freq. [VAC/Hz] (±10%)	Resistance at 20°C [Ω] (±5%)	Current consumption at inrush [A] (±10%)	Current consumption at holding [A] (±5%)	Power consumption at inrush (±10%) [VA]	Power consumption at holding (±10%) [VA]	Coil code K1
C26L5-A24K1	24/50	0,58	15,1	2,84	362,4	68,2	1903160
C26L5-A48K1	48/50	2,34	7,4	1,29	355,2	61,9	1903161
C26L5-A110K1	110/50-120/60	12,3	3,6 - 3,3	0,64 - 0,62	396	70,4 - 74,4	1903162
C26L5-A230K1	230/50-240/60	51,6	1,8 - 1,6	0,31 - 0,28	414 - 384	71,3 - 67,2	1903163

8 - ELECTRIC CONNECTORS

Solenoid operated valves are delivered without connectors. Connectors can be ordered separately. See catalogue 49 000.

9 - INSTALLATION

The configuration with centring and return springs can be mounted in any position.

Valve fitting takes place by means of screws or tie rods, fixing the valve on a lapped surface, with values of planarity and smoothness that are equal to or better than those indicated in the drawing. If the minimum values of planarity or smoothness are not met, fluid leakages between valve and mounting surface can easily occur.

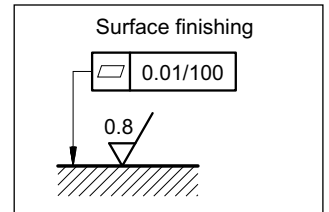

10 - DL5 DC OVERALL AND MOUNTING DIMENSIONS

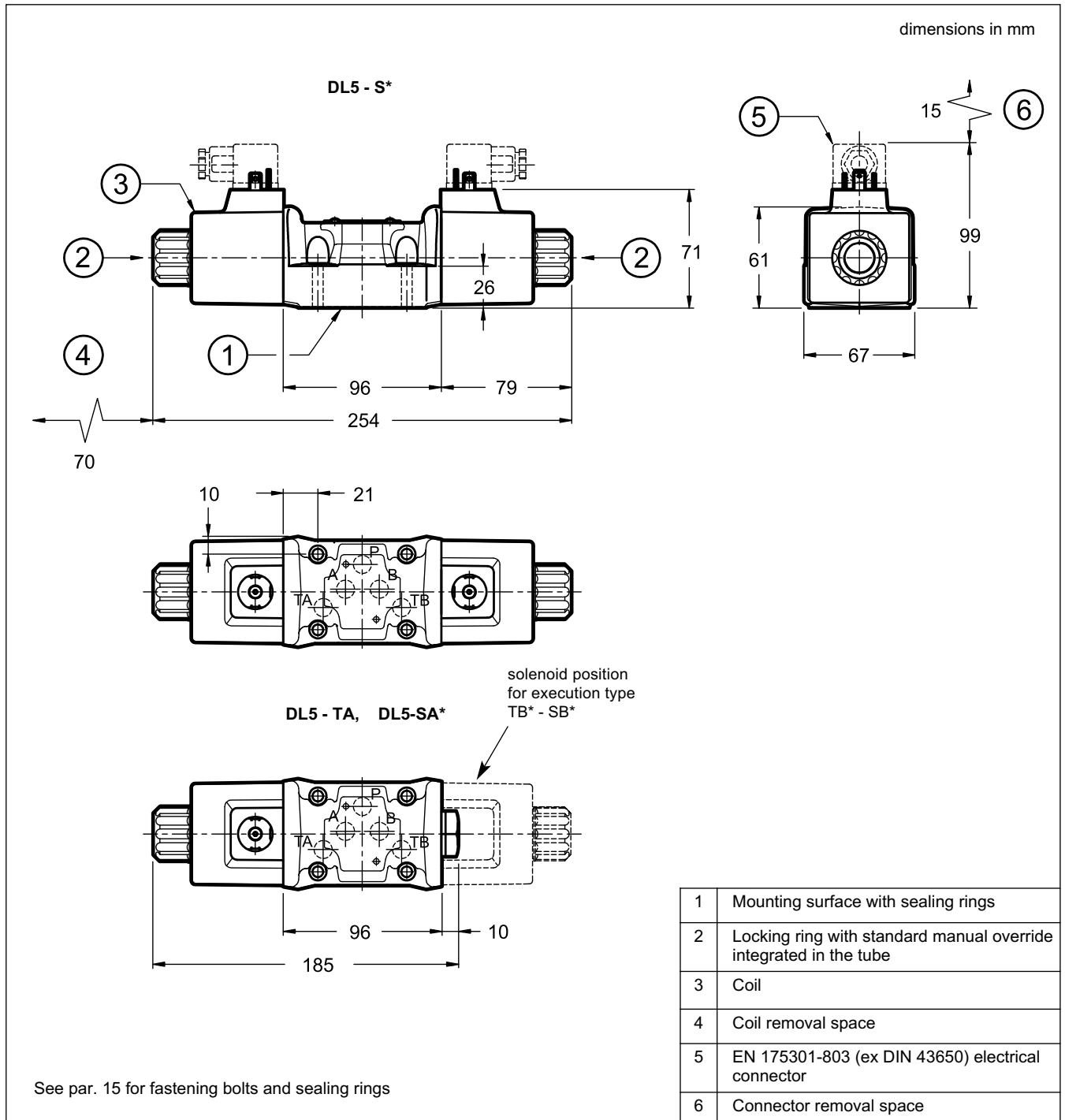

11 - DL5 AC OVERALL AND MOUNTING DIMENSIONS

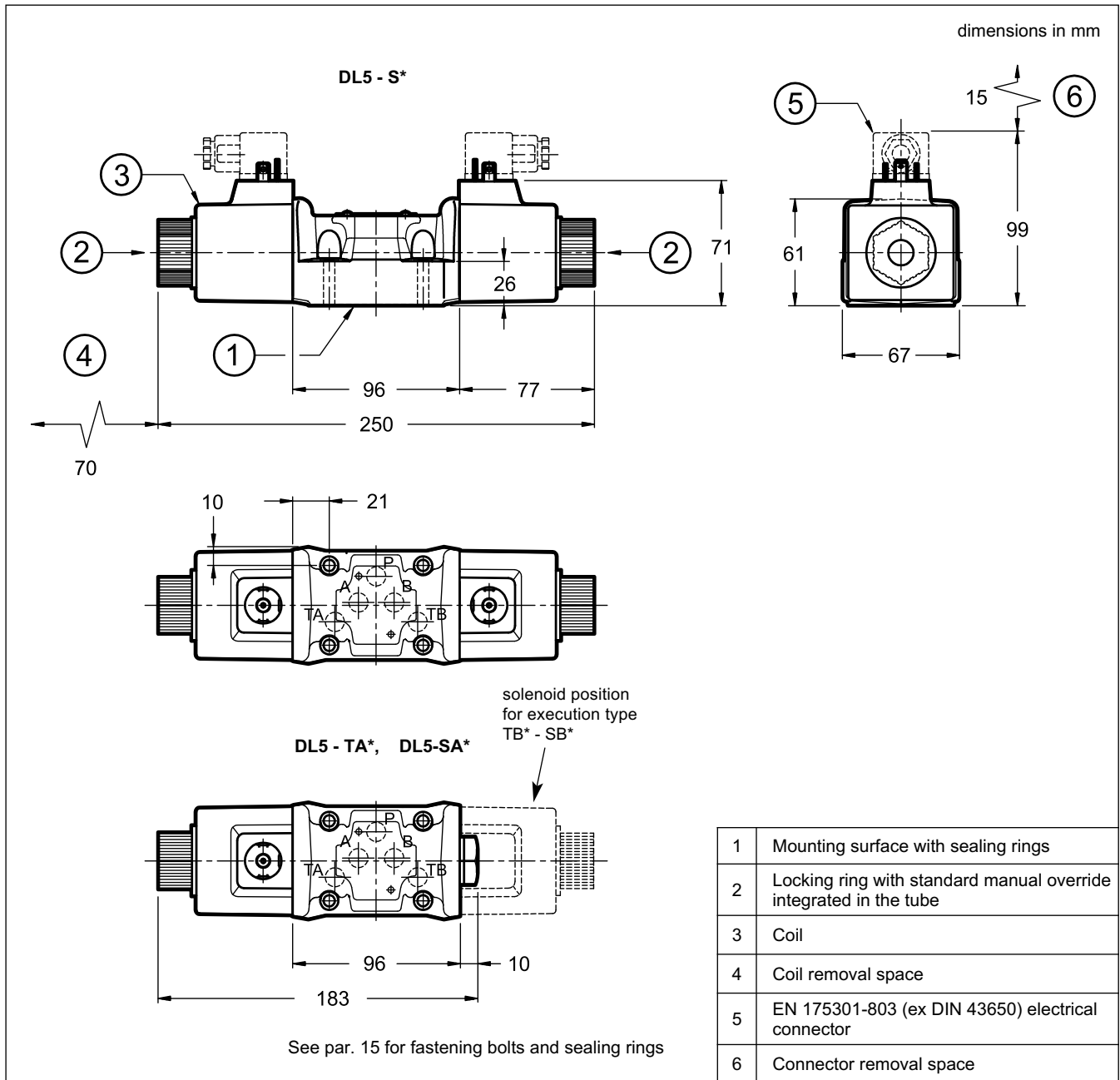

12 - OPTIONAL MANUAL OVERRIDE

12.1 - Boot protected manual override (only for DC solenoid valve)

It can be ordered by entering the code **CM** in the identification code at par. 1, or is available as option to be ordered separately: code **3401150006**.

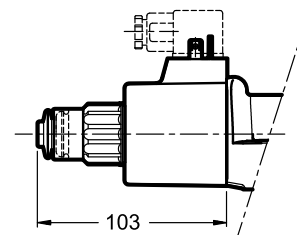

13 - SPARE PARTS FOR DC SOLENOID VALVE

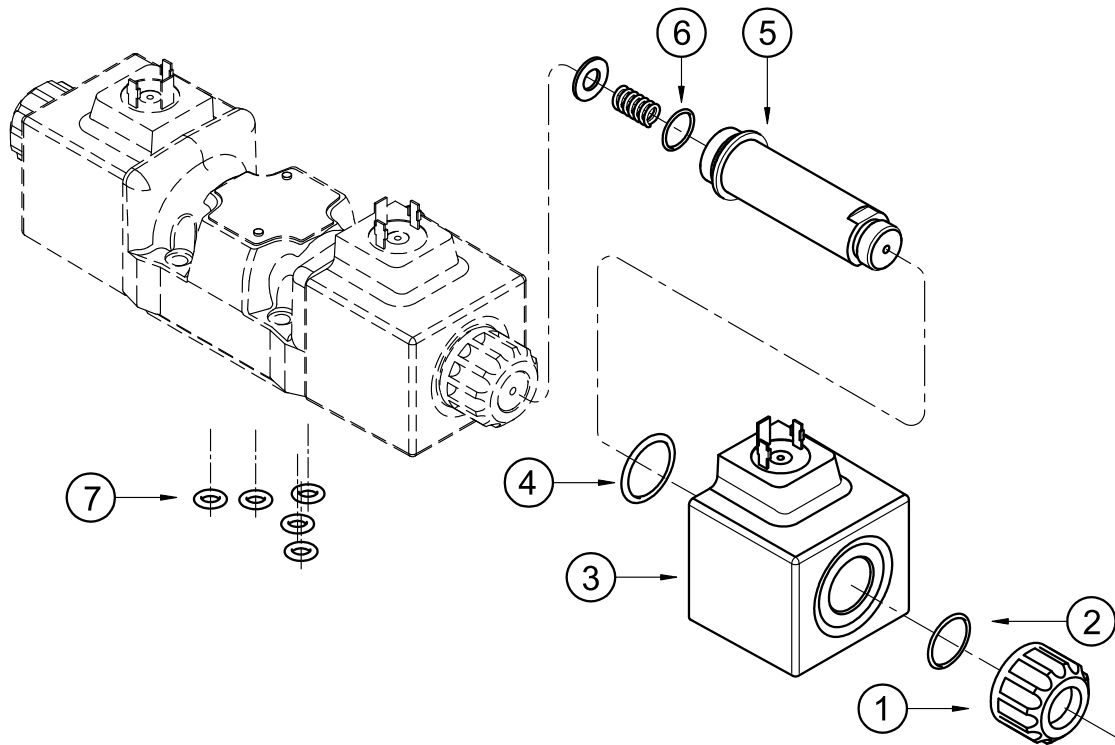

IDENTIFICATION CODE FOR DC AND RC COILS

C 22 L5 - K1 / 10

Supply voltage
D12 = 12 V
D24 = 24 V

Series no.:
 (the overall and
 mounting dimensions
 remain unchanged
 from 10 to 19)

Coil electrical connection:
 plug for connector type
 EN 175301-803 (ex DIN 43650)
 (standard)

1	Coil locking ring - code 0119412
2	ORM-0220-20 - 70 shore
3	Coil (see identification code)
4	ORM-0296-24 (29.6x2.4) - 70 shore
5	Solenoid tube: TD22-DL5/10N (NBR seals) TD22-DL5/10V (FPM seals) (OR n° 6 included)
6	OR type 3.910 (19.18x2.46) - 70 shore
7	N. 5 OR type 2050 (12.42x1.78) - 90 Shore

SEAL KIT

The codes included the OR n° 2, 4, 6 and 7.

Cod. 1985447 NBR seals
Cod. 1985448 FPM seals

14 - SPARE PARTS FOR AC SOLENOID VALVE

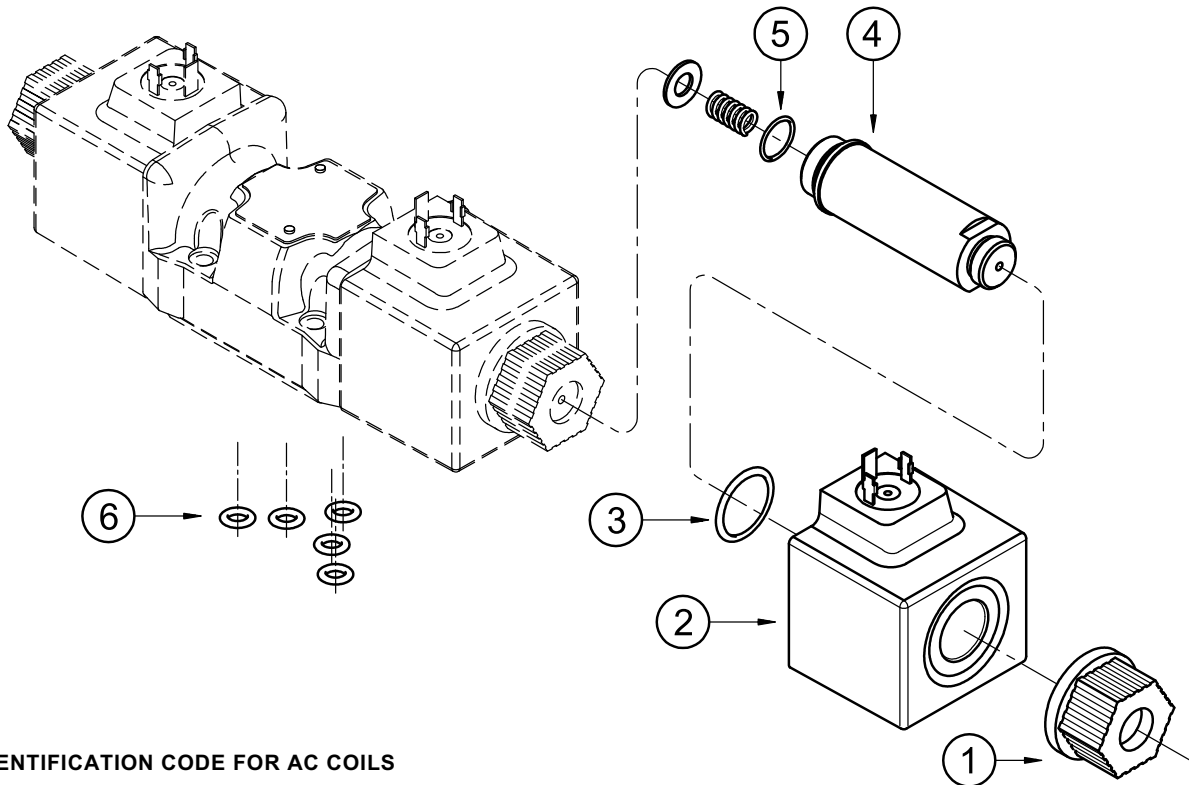

IDENTIFICATION CODE FOR AC COILS

C 26 L5 - K1 / 10

Series no.:
(the overall and mounting dimensions remain unchanged from 10 to 19)

Coil electrical connection:
plug for connector type
EN 175301-803 (ex DIN 43650)
(standard)

Supply voltage

A24 = 24 V - 50 Hz
A48 = 48 V - 50 Hz
A110 = 110 V - 50 Hz / 120 V - 60 Hz
A230 = 230 V - 50 Hz / 240 V - 60 Hz

1	Coil locking ring - code. 0119480
2	Coil (see identification code)
3	ORM-0296-24 (29.6x2.4) - 70 shore
4	Solenoid tube: TA26-DL5/10N (NBR seals) TA26-DL5/10V (FPM seals) (OR n° 5 included)
5	OR type 3.910 (19.18x2.46) - 70 shore
6	N. 5 OR type 2050 (12.42x1.78) - 90 Shore

SEAL KIT

The codes included the OR n° 3, 5 and 6.

Cod. 1985449 NBR seals
Cod. 1985450 FPM seals

15 - FASTENING BOLTS AND SEALING RINGS

Single valve fastening: 4 SHC screws ISO 4762 M6x35

Tightening torque: 8 Nm

Sealing rings: N. 5 OR type 2050 (12.42x1.78) - 90 Shore

16 - SUBPLATES

(see catalogue 51 000)

Type PMD4-AI4G with rear ports - port threading: 3/4" BSP

Type PMD4-AL4G with side ports - port threading: 1/2" BSP

Архангельск (8182)63-90-72
Астана (7172)727-132
Астрахань (8512)99-46-04
Барнаул (3852)73-04-60
Белгород (4722)40-23-64
Брянск (4832)59-03-52
Владивосток (423)249-28-31
Волгоград (844)278-03-48
Вологда (8172)26-41-59
Воронеж (473)204-51-73
Екатеринбург (343)384-55-89
Иваново (4932)77-34-06

Ижевск (3412)26-03-58
Иркутск (395)279-98-46
Казань (843)206-01-48
Калининград (4012)72-03-81
Калуга (4842)92-23-67
Кемерово (3842)65-04-62
Киров (8332)68-02-04
Краснодар (861)203-40-90
Красноярск (391)204-63-61
Курск (4712)77-13-04
Липецк (4742)52-20-81

Магнитогорск (3519)55-03-13
Москва (495)268-04-70
Мурманск (8152)59-64-93
Набережные Челны (8552)20-53-41
Нижний Новгород (831)429-08-12
Новокузнецк (3843)20-46-81
Новосибирск (383)227-86-73
Омск (3812)21-46-40
Орел (4862)44-53-42
Оренбург (3532)37-68-04
Пенза (8412)22-31-16

Пермь (342)205-81-47
Ростов-на-Дону (863)308-18-15
Рязань (4912)46-61-64
Самара (846)206-03-16
Санкт-Петербург (812)309-46-40
Саратов (845)249-38-78
Севастополь (8692)22-31-93
Симферополь (3652)67-13-56
Смоленск (4812)29-41-54
Сочи (862)225-72-31
Ставрополь (8652)20-65-13

Сургут (3462)77-98-35
Тверь (4822)63-31-35
Томск (3822)98-41-53
Тула (4872)74-02-29
Тюмень (3452)66-21-18
Ульяновск (8422)24-23-59
Уфа (347)229-48-12
Хабаровск (4212)92-98-04
Челябинск (351)202-03-61
Череповец (8202)49-02-64
Ярославль (4852)69-52-93

Киргизия (996)312-96-26-47

Россия (495)268-04-70

Казахстан (772)734-952-31

<https://diplomatic-nt-rt.ru/> || dcw@nt-rt.ru